

ICX

THE FAIR
PREMIUM
IMPLANT-
SYSTEM.

September 2022/01

ICX-MULTI[®] CONCEPT MANUAL 2.0

4-ON-ICX (MANDIBLE)

3 TO 8 UNIT IMPLANT SUPPORTED BRIDGES
AND WHOLE JAW SOLUTIONS

6-ON-ICX (MAXILLA)



BE SMART. BE ICX.

medentis[®]
medical

ICX-MULTI[®] CONCEPT

MANUAL 2.0

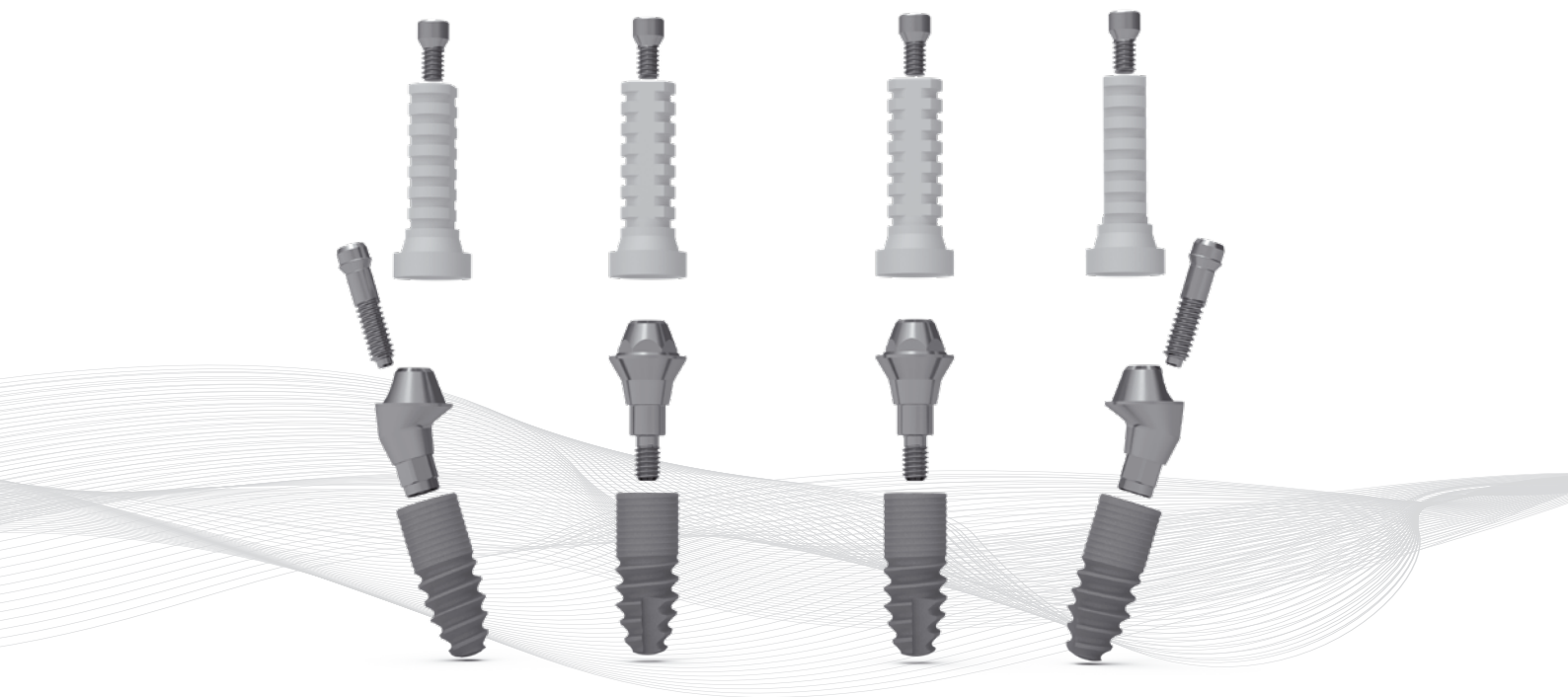

ICX-SHOP!



BE SMART. BE ICX.



Content

THE ICX-MULTI[®] CONCEPT

What does the ICX-MULTI[®] system stand for
and what possibilities does it offer? 4-7

PRACTICAL PROCEDURE

Angled ICX-MULTI[®] abutments 8

Straight ICX-MULTI[®] abutments 9

PROSTHETIC SOLUTIONS

Impression - closed and open 10-11

ICX-CAD/CAM 11

ICX-MAXIMUS 12

ICX-MULTI[®] Adhesive base 13

OVERVIEW

The ICX-MULTI[®] product range 14-16



DIGITAL. DENTAL. FINAL.

medentis[®]
medical

THE ICX-MULTI® CONCEPT: 4-on-ICX and 6-on-ICX

Following the ICX-MULTI® Concept will enable you to successfully rehabilitate the edentulous patient without the need for bone reconstruction at a reasonable cost.

Procedures can be carried out with or without the use of a navigation software and depending on bone quality and quantity even immediate loading is possible.

For many patients, this can bring the fixed solution they have been dreaming about within financial reach. The fair pricing of our ICX premium implants contributes largely to this.



ICX-MULTI® – fixed teeth for satisfied patients.

Bridge restoration in the mandible (4-on-ICX) with the ICX-MULTI® concept

- No decementation or loosening of the distal abutments, as implant sites are outside the twisting area of the mandibular brace
- Four implants (no nerve lateralisation)
- Fixed bridge restoration
- Reduction of costs

4-ON-ICX (MANDIBLE)



Bridge restoration in the maxilla (6-on-ICX) with the ICX-MULTI® concept

- Six implants (palate-free restoration)
- Avoid sinuslift
- Reduction of treatment time
- Reduction of costs

6-ON-ICX (MAXILLA)

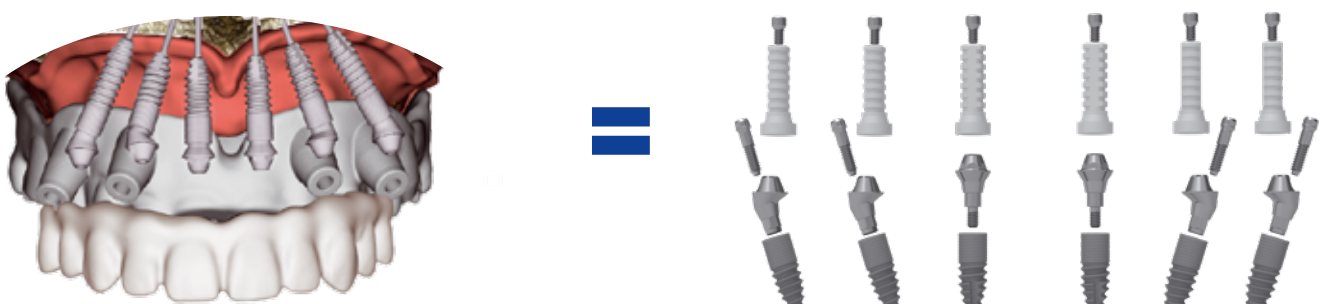

THE ICX-MULTI® CONCEPT: 4-on-ICX and 6-on-ICX

Utilising clever design features, we could reduce the minimal height from 9.7mm to 5.5mm.
Different gingival heights are available.

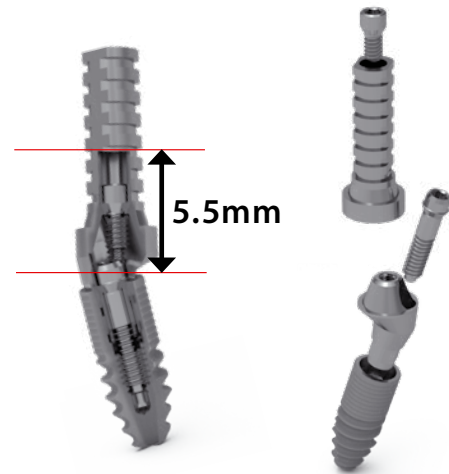

Easy transfer with customised holder.
Holder doubles as reference for parallelism.
(see picture:
ICX-MULTI® with holder/parallelism reference)



DESIGN CONSTRUCTION BY ICX-DENTA5

CAD/CAM connection offers a variety of prosthetic options. By using the ICX-denta5 service for your prosthetics or design them yourself thanks to the possibilities offered by CAD/CAM.

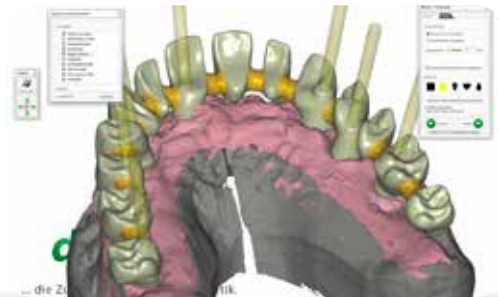

Via the ICX-MULTI® Concept you also have the option to correct diverging angles of abutments for the use of LOCATOR™/Maximus® connectors.



THE ICX-MULTI® CONCEPT: 4-on-ICX and 6-on-ICX

*ICX-MULTI® Abutment,
35°*

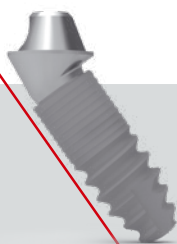

*ICX-MULTI® Abutment,
17°*



*ICX-MULTI® Abutment
straight*



The angulation can be exactly pre-determined by case-planning in the ICX-MAGELLAN software.



medentis
medical

ICX-MULTI[®] CONCEPT

MANUAL 2.0

4-ON-ICX (MANDIBLE)

3 TO 8 UNIT IMPLANT SUPPORTED BRIDGES
AND WHOLE JAW SOLUTIONS

6-ON-ICX (MAXILLA)



ICX-SHOP!



THE ICX-MULTI® CONCEPT: Practical procedure

ANGLED ICX-MULTI® ABUTMENTS



1 The abutment is delivered in a blister pack. A parallelism reference tool is included in the pack.



2 Angulated ICX-MULTI abutments have to be assembled with a 1.2 screw driver. The screw canal is axial.



3 The parallelism reference tool is connected to the occlusal thread.



4 The ICX-MULTI abutment ready for connection to the implant.



5 The ICX-MULTI abutment can be connected to the implant in the optimum angulation/parallel to the other ICX-MULTI abutments thanks to the parallelism reference tool.



6 Angulated ICX-MULTI abutments are tightened to the implants with a 1.2 screw driver.



7 The connection screw is tightened to 30Ncm.



8 As soon as two or more parallelism reference tools are connected to the abutments, it is possible to check and correct parallelism of the abutments.



medentis
medical

THE ICX-MULTI® CONCEPT: Practical procedure

STRAIGHT ICX-MULTI® ABUTMENTS



1 The abutment is delivered in a blister pack. A carrier is included in the pack. The abutment is inserted into the carrier.



2 The straight abutment is placed onto the implant and tightened with the provided carrier.



3 After the abutment is placed finger tight, the carrier can be removed with an audible 'click'.



4 The abutment is further tightened with the ICX-MULTI tool for straight abutments.



5 The screw is tightened to a torque of 30Ncm.



6 As soon as two or more parallelism reference tools are connected to the abutments, it is possible to check and correct parallelism of the abutments.

ICX-SHOP!



BE SMART. BE ICX.



THE ICX-MULTI® CONCEPT: Prosthetic solutions

CLOSED TRAY IMPRESSION



1 The blister pack contains an ICX-MULTI impression post and an impression cap.



2 The impression post is placed onto the ICX-MULTI abutment.



3 The impression post is then tightened finger tight.



4 Ensure correct orientation of the impression cap when placing on the impression post. The flat surfaces must match.



5 Correct seating of the impression cap on the impression post will be confirmed by an audible 'click'. The impression can now be taken.



medentis[®]
medical

THE ICX-MULTI® CONCEPT: Prosthetic solutions

OPEN TRAY IMPRESSION



1
The blister pack contains the ICX-MULTI impression post with screw and a screw canal protector cap.



2
The ICX-MULTI impression post has its own screw which has to be tightened with a 1.2 screw driver.



3
The impression post is placed onto the ICX-MULTI abutment.



4
The impression post is tightened finger tight.



5
The screw canal protector cap is placed onto the impression post as a protection from impression material.



ICX-MULTI® CAD/CAM



1
The scan abutment is delivered in a blister pack.



2
The scan abutment is placed onto the ICX-MULTI abutment.



3
The scan abutment is tightened.

THE ICX-MULTI® CONCEPT: Prosthetic solutions

A large variety of options is available for the prosthetic restoration of ICX-MULTI abutments.

Please note:

Overdentures with telescopic connectors **are not compatible** with ICX-MULTI® abutments.

ICX-MAXIMUS®

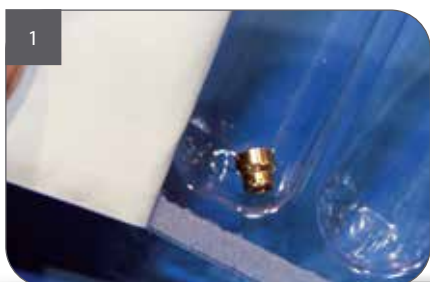

The ICX-Maximus cap is delivered in a blister pack.



The ICX-Maximus cap is screwed directly onto the ICX-MULTI abutment.



The ICX-MULTI abutment is ready for insertion.



The screw on the abutment is tightened to a torque of 27Ncm.



The use of ICX-MULTI abutment provides the option of angulating the LOCATOR™/Maximus® connectors.

THE ICX-MULTI® CONCEPT: Prosthetic solutions

ICX-MULTI® BONDED ABUTMENTS



1
The abutment is delivered in a blister pack.



2
There are special occlusal screws for the ICX-MULTI abutment prosthetics. For this, the hexagonal SW 1.2mm is required.



3
The bonded abutment is placed onto the ICX-MULTI abutment.



4
Tightening of the abutment.



5
The screw on the abutment is torqued to 27Ncm.



6
The use of the bonded abutment provides several options for the prosthetic restoration.



7
Screw retained bridges made from various materials.





8
Bar retained prosthetics.

medentis
medical



Overview: The ICX-MULTI® product range

**Only for bar, bridge and splinted crown restorations -.
not suitable for single-tooth and telescopic restorations!**

Required minimum height 5.5mm / screwdriver SW 1.2mm

Article-No.		Article	Dimensions	Material
C-020-750000		Only for BL! ICX-MULTI abutmebt, straight, GH 0mm	Ø 4.8mm GH 0mm K 2.2mm	Titaniumn
C-020-750001		Only for TL! ICX-MULTI abutmebt, straight, GH 0mm	Ø 4.8mm GH 0mm K 2.2mm	Titanium

required minimum height 5,5mm / screwdriver SW 1,2mm

Article-No.		Article	Dimensions	Material
C-020-750010		ICX-MULTI abutment, straight, one-piece	GH 1mm K 2.2mm	Titanium
C-020-750020		ICX-MULTI abutment, straight, one-piece	GH 2mm K 2.2mm	Titanium
C-020-750030		ICX-MULTI abutment, straight, one-piece	GH 3mm K 2.2mm	Titanium
C-020-750040		ICX-MULTI abutment, straight, one-piece	GH 4mm K 2.2mm	Titanium
C-020-750050		ICX-MULTI abutment, straight, one-piece	GH 5mm K 2.2mm	Titanium
C-020-751705		17° ICX-MULTI abutment, rotation-locked in implant	GH short 0.5mm GH long 1.9mm K 2.2mm	Titanium
C-020-751715		17° ICX-MULTI abutment, rotation-locked in implant	GH short 1.5mm GH long 2.9mm K 2.2mm	Titanium
C-020-751735		17° ICX-MULTI abutment, rotation-locked in implant	GH short 3.5mm GH long 4.9mm K 2.2mm	Titanium
C-020-753505		35° ICX-MULTI abutment, rotation-locked in implant	GH short 0.5mm GH long 3.25mm K 2.2mm	Titanium
C-020-753515		35° ICX-MULTI abutment, rotation-locked in implant	GH short 1.5mm GH long 4.25mm K 2.2mm	Titanium
C-020-753535		35° ICX-MULTI abutment, rotation-locked in implant	GH short 3.5mm GH long 6.25mm K 2.2mm	Titanium

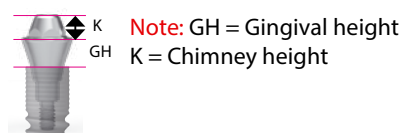



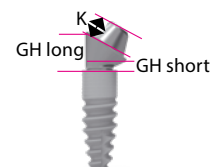









 incl. base screw C-020-000010
(connection screw to the implant)



Overview: The ICX-MULTI® product range

Required minimum construction height is 5.5mm



Article-No.		Article	Dimensions	Material
C-003-000005		ICX-MULTI Protection cap	Ø 4.8 L 4.6mm	Titanium
C-005-070001		ICX-MULTI impression posts, closed, incl. impression cap	L 11mm	Titanium
C-005-070002		ICX-MULTI impression posts, open, short incl. impression aid	L 13mm	Titanium
C-005-070020		ICX-MULTI impression posts, open, long incl. impression aid	L 16.7mm	Titanium
C-006-010007		ICX-MULTI Model analog CAD/CAM	L 11mm K 2,mm	Titanium
C-020-951120		ICX-MULTI Prosthetic abutment, Titanium	Ø 4.8 L 12mm (shortenable to 4.1mm)	Titanium
C-020-952120		ICX-MULTI Prosthetic abutment, Plastic	Ø 4.8 L 12mm (shortenable to 4.1mm)	Plastic burnable
C-020-953120		ICX-MULTI Prosthetic abutment PEEK (PROVISIONAL/BITE REGISTRATION)	Ø 4.8 L 12mm (shortenable to 4.1mm)	Peek
C-029-002010		ICX-MULTI adhesive base (for bars and resin veneer bridges)	Ø 4.8 L 5.5mm	Titanium
C-029-002011		ICX-MULTI adhesive base GH 0mm, (for ceramic veneer bridges)	Ø 5.4mm, L 5.5mm	Titanium
C-030-000010		ICX-MULTI Scan cap	L 12.5mm B 4.5mm T 6.5mm	Peek
C-030-000013		ICX MULTI Scan base narrow	Ø 4.10mm L 10mm	Titan
C-031-100001		ICX-Maximus cap, GH 3mm, (additionally to GH ICX-MULTI abutment)	Ø 4.8 L 4.4mm	Titanium



incl. prosthetic screw C-020-000011 (connection screw to ICX-MULTI abutment)

Overview:



The ICX-MULTI® product range

Article-No.		Article	Dimensions	Material
C-020-956120		ICX-MULTI prosthetic abutment CoCr Biodur CCM/BC NEM cast-on	Ø 4.8mm L 7mm	CoCr Biodur CCM/ BC
C-020-955120		ICX-MULTI welding abutment 1st generation for welding of several abutments with the aid of a titanium wire	Ø 4.8mm L 12mm	Titanium
C-020-955121		ICX-MULTI welding abutment 2nd generation for welding of several abutments with the aid of a titanium wire	Ø 5.1mm L 10.5mm	Titanium

 incl. prosthetic screw C-020-000011
(connection screw for the ICX-MULTI abutment)



Field of application and indication

The ICX-MULTI® concept is a prosthetic concept for immediate restoration of edentulous patients. For better support of the subsequent restoration, it is possible for the posterior implants to be placed at a 17° or 35° angle distally. This angulation is compensated by the special abutments.

Article-No.	Article	Dimensions	Material	
C-015-100030	ICX-MULTI Hex tool SW 1.2mm medium	SW 1.2mm	Stainless steel	
C-020-000001	ICX-MULTI insertion tool SW 3,2mm for straight MULTI abutments Mandatory!	SW 3.2mm	Stainless steel	

ICX-MULTI abutments without rotation lock to the implant.

Additional angling over edge possible.

Article-No.		Article	Dimensions	Material
C-020-851705		17° ICX-MULTI abutment, not rotation-locked in implant	GH short 0.5mm GH long 1.9mm K 2.2mm	Titanium
C-020-851715		17° ICX-MULTI abutment, not rotation-locked in implant	GH short 1.5mm GH long 2.9mm K 2.2mm	Titanium
C-020-851735		17° ICX-MULTI abutment, not rotation-locked in implant	GH short 3.5mm GH long 4.9mm K 2.2mm	Titanium
C-020-853505		35° ICX-MULTI abutment, not rotation-locked in implant	GH short 0.5mm GH long 3.25mm K 2.2mm	Titanium
C-020-853515		35° ICX-MULTI abutment, not rotation-locked in implant	GH short 1.5mm GH long 4.25mm K 2.2mm	Titanium
C-020-853535		35° ICX-MULTI abutment, not rotation-locked in implant	GH short 3.5mm GH long 6.25mm K 2.2mm	Titanium

ICX

DAS FAIRE
PREMIUM
IMPLANTAT-
SYSTEM.



ICX-SHOP!





ICX-SHOP!



BE SMART. BE ICX.



ICX

THE FAIR
PREMIUM
IMPLANT-
SYSTEM.

September 2022

ICX-MULTI[®] CONCEPT MANUAL 2.0

4-ON-ICX (MANDIBLE)

3 TO 8 UNIT IMPLANT SUPPORTED BRIDGES
AND WHOLE JAW SOLUTIONS

6-ON-ICX (MAXILLA)



medentis medical GmbH

Walporzheimer Str. 48-52 · 53474 Bad Neuenahr/Ahrweiler · Germany

Tel.: +49 (0)2641 9110-0 · www.medentis.de

mm02432

BE SMART. BE ICX.

medentis[®]
medical